

JOB NAME _____ LOCATION _____
 PURCHASER _____ ORDER NO. _____
 ENGINEER _____
 SUBMITTED TO _____ FOR: Reference Approval Construction
 SUBMITTED BY _____ DATE _____

UNIT DESIGNATION: Schedule No. _____ MODEL NO. _____

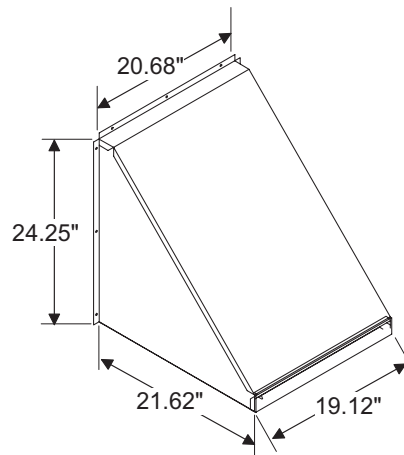
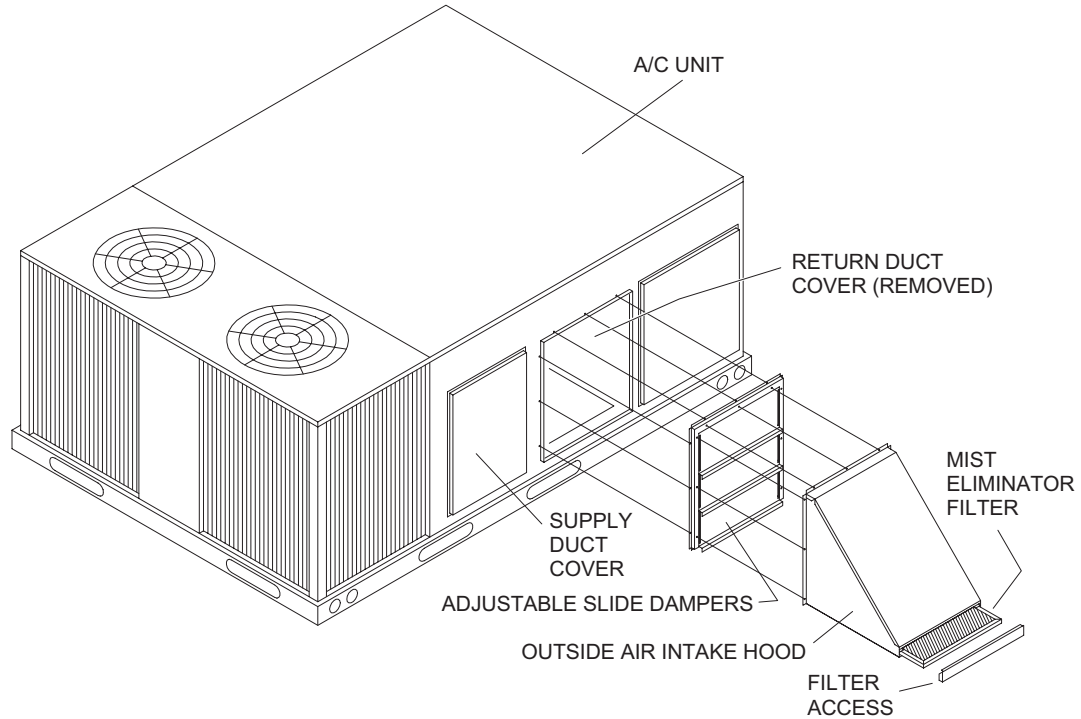

NOTE:

The 0-35% manual outside air system is designed to replace the unit duct cover. No drilling on the unit or field assembly is required. The amount of outside air is controlled by simply adjusting the slide damper.

Copyright © 1998 by Unitary Products Group - ALL RIGHTS RESERVED

**MANUAL OUTDOOR AIR DAMPER
 ACCESSORY, 0% THRU 35% CAPABILITY
 MODEL 1FA0407**

FORM 530.18-SD1.15Y (698)

Supersedes: Nothing

